

Designation System:

- CA = **C**hip **A**rray
- 06 = Dimensions of the device **06**x12 (Length x width in 1/100 inch)
- P = Design (**P**arallel internal structure)
- 4 = Number of elements
- S...A = **S**pecial tolerance **A** of the varistor voltage
- 17 = Max. operating voltage
- LC = **L**ow **C**apacitance
- G = Taped version (blister tape, 7" reel, 3000 pieces/reel)
- K2 = Silver-platinum termination (Ag/Pt)

Figure:

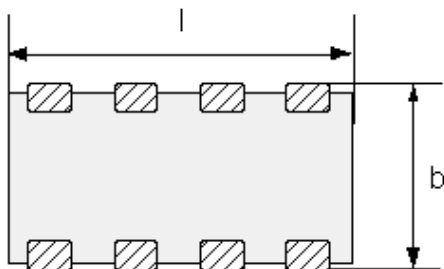

- $l = 3,2 \pm 0,2$
- $b = 1,6 \pm 0,15$
- $s = 0,9 \text{ max.}$
- $d = 0,4 \pm 0,15$
- $e = 0,76 \pm 0,15$

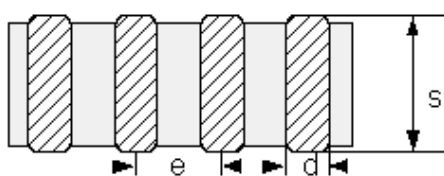

Coplanarity < 0.1

(All dimensions in mm)

As far as patents or other rights of third parties are concerned, liability is only assumed for components per se, not for applications, processes and circuits implemented within components or assemblies. The information describes the type of component and shall not be considered as assured characteristics. Terms of delivery and rights to change design reserved.

ISSUE DATE	12.07.02	ISSUE	e	PUBLISHER	KB VS PE	PAGE	1/6
------------	----------	-------	---	-----------	----------	------	-----

V-I-Characteristic:

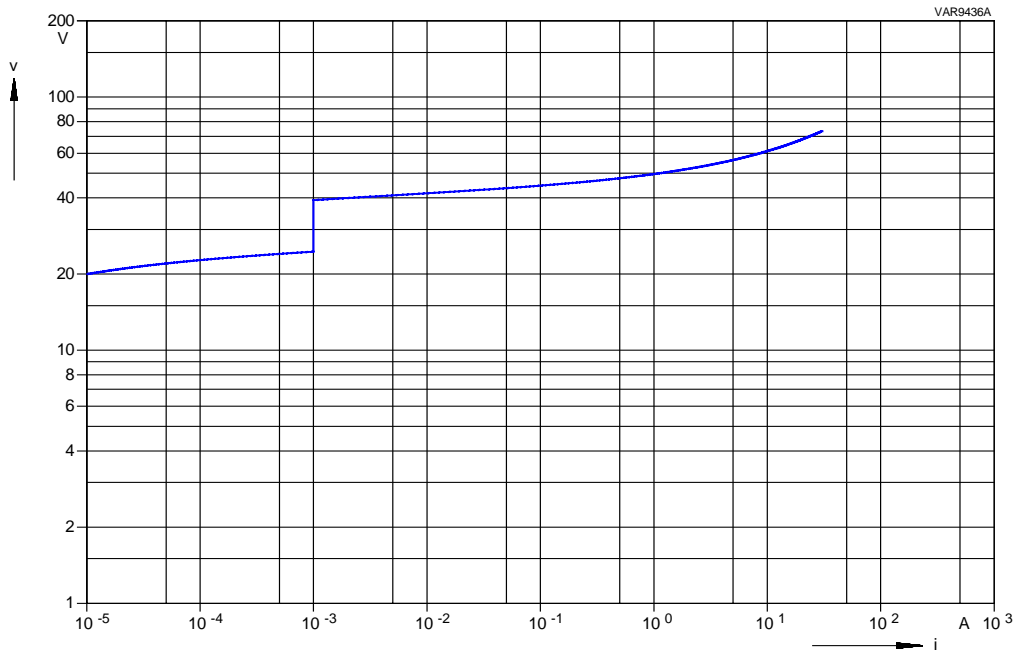

Derating Field:

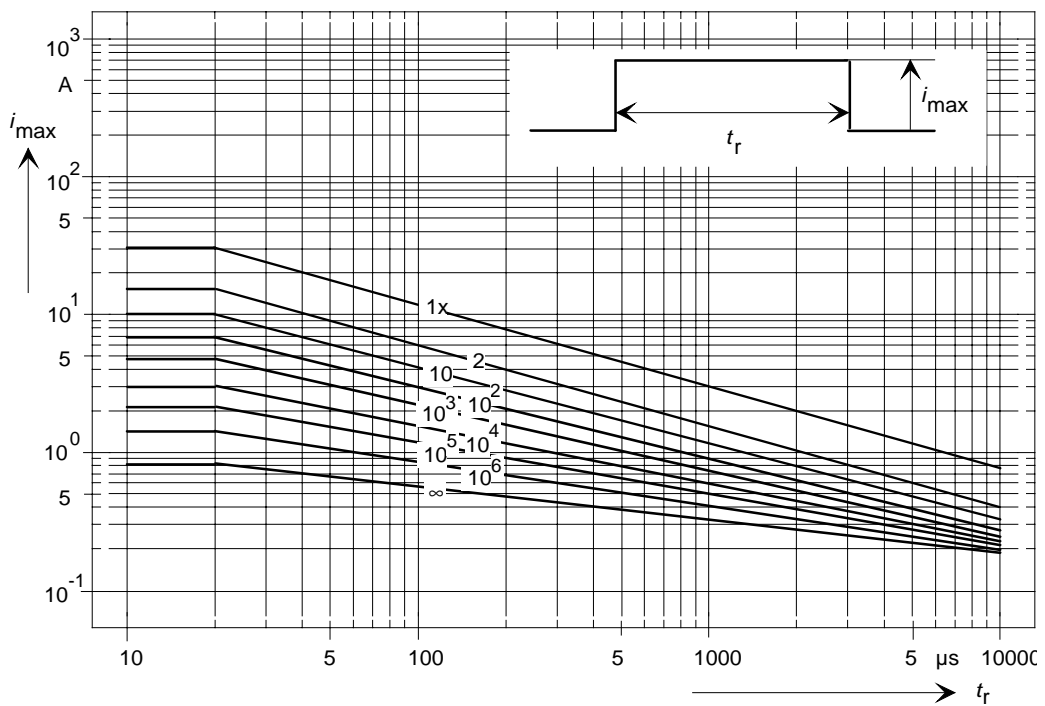

Electrical Data

Max. operating voltage

RMS voltage

 $V_{\text{eff}} = 17 \text{ V}$

DC voltage

 $V_{\text{DC}} = 22 \text{ V}$

Varistor voltage (@ 1 mA)

 $V_V = 25 - 40 \text{ V}$

Max. clamping voltage (@ 1 A)

 $V_C = 50 \text{ V}$

Max. average power dissipation

 $P_{\text{max}} = 3 \text{ mW}$

 Max. surge current (8/20 μs)

 $\hat{I}_{\text{max}} = 1 \times 30 \text{ A}$

Max. energy absorption (2 ms)

 $E_{\text{max}} = 1 \times 0.075 \text{ J}$

Capacitance (@ 1MHz, 0.5 V)

 $< 75 \text{ pF}$

Response time

 $< 0.5 \text{ ns}$

Operating temperature

 $-30 \dots +85 \text{ }^\circ\text{C}$

Storage temperature (mounted parts)

 $-40 \dots +125 \text{ }^\circ\text{C}$

Termination material

AgPt

 (thickness not specified, adjusted to fulfill wettability specification acc. to **IEC 60068-2-58**)

Part weight

0.02 g

Max. current, energy, operating voltage and average
depending on ambient temperature

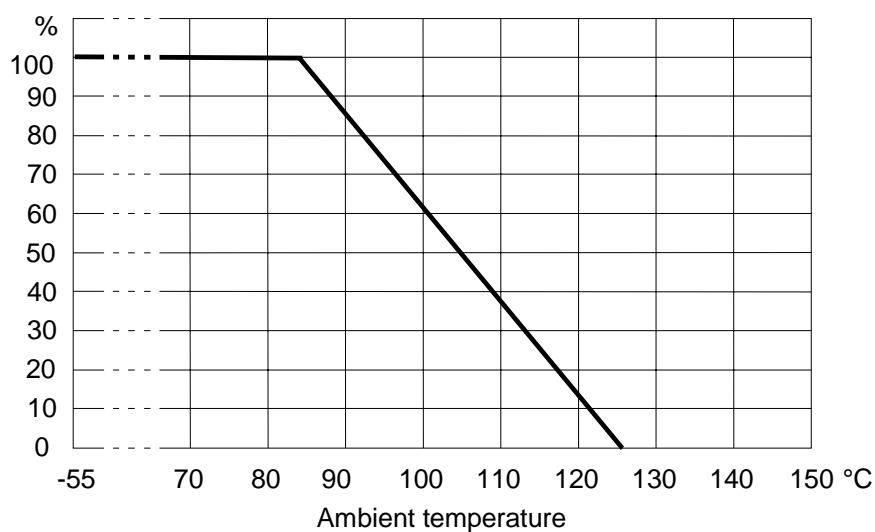

Recommended Geometry of Solder Pads

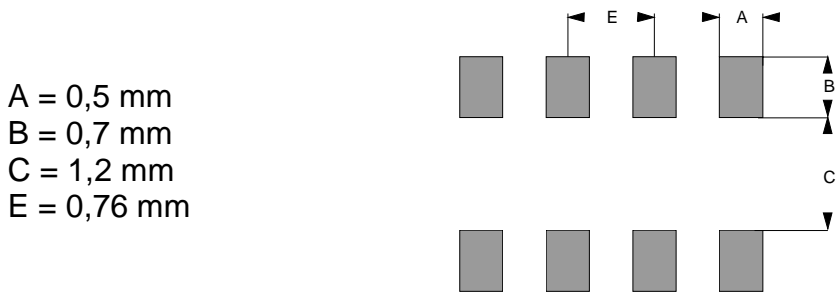

A = 0,5 mm
 B = 0,7 mm
 C = 1,2 mm
 E = 0,76 mm

Recommended Soldering Temperature Profiles

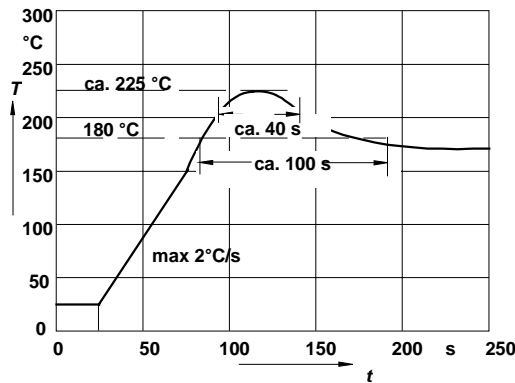

This component is only suited for IR-soldering at relatively low temperatures and must not be wave soldered because of dissolution of the metallization!

Max. reflow temperature: 235° C, 30 sec
 220° C, 45 sec.
 Max. reflow cycles: 2 x .

As far as possible, the components shall be employed within 6 months. They should be left in their original packings to avoid soldering problems due to oxidized contacts.

Storage temperature: -25 to 45°C

Relative humidity: <75% annual average, <95% on max. 30 days in a year.

The usage of mild, non activated fluxes for soldering is recommended, as well as a proper cleaning of the PCB.

ISSUE DATE	12.07.02	ISSUE	e	PUBLISHER	KB VS PE	PAGE	4/6
------------	----------	-------	---	-----------	----------	------	-----

Taping According to IEC 60286-3

Dimensions and tolerances

Tape material: plastic embossed

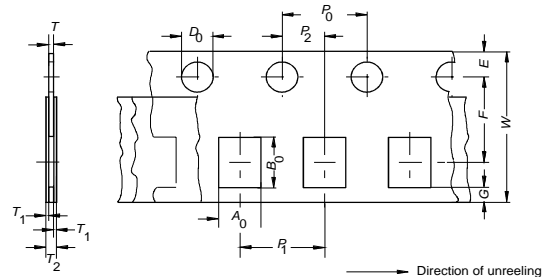

Definition	Symbol	Dim.	Tolerance
Compartment width	A_0	1.9	± 0.2
Compartment length	B_0	3.5	± 0.2
Compartment height	K_0	1.3	max.
Sprocket hole diameter	D_0	1.5	+0.1 /-0
Compartment hole diameter	D_1	1.0	min.
Sprocket hole pitch	P_0	4.0	± 0.1 ¹⁾
Distance center hole to center compartment	P_2	2.0	± 0.05
Pitch of the component compartments	P_1	4.0	± 0.1
Tape width	W	8.0	± 0.3
Distance edge to center of hole	E	1.75	± 0.1
Distance center hole to center compartment	F	3.5	± 0.05
Overall thickness	T_2	2.5	max.

¹⁾ $\leq \pm 0.2$ mm over any 10 pitches

Tape end (trailer)

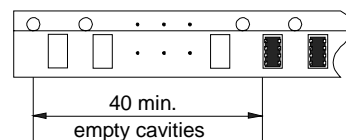

Leader

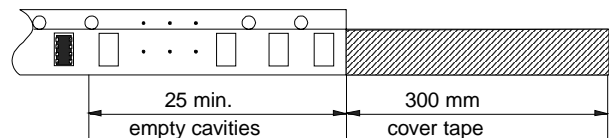

Data sheet

Package

Each reel in airtight plastic bag with desiccant bag.
Dimensions approx. 220 x 200 mm.

Package: 8 mm tape

Reel material: plastic

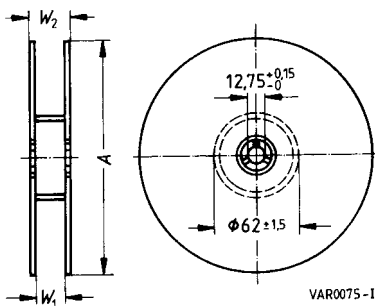

Definition	Symbol	Dim.	Tol.
Reel diameter	A	180	-2
Reel width (inside)	W_1	8.4	+1.5 /-0
Reel width (outside)	W_2	14.4	max.

© EPCOS AG 2002. Reproduction, publication and dissemination of this data sheet, enclosures hereto and the information contained therein without EPCOS' prior express consent is prohibited.

Purchase orders are subject to the General Conditions for the Supply of Products and Services of the Electrical and Electronics Industry recommended by the ZVEI (German Electrical and Electronic Manufacturers' Association), unless otherwise agreed.

ISSUE DATE	12.07.02	ISSUE	e	PUBLISHER	KB VS PE	PAGE	6/6
------------	----------	-------	---	-----------	----------	------	-----